

Full - Bridge MOSFET Power Module

$V_{DSS} = 1000V$
 $R_{DSon} = 350m\Omega \text{ typ @ } T_j = 25^\circ C$
 $I_D = 22A \text{ @ } T_c = 25^\circ C$

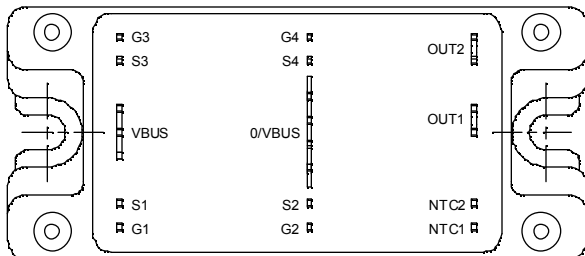
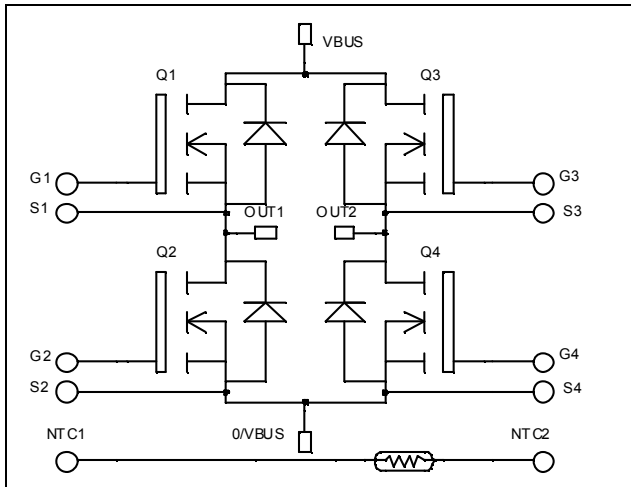

Application

- Welding converters
- Switched Mode Power Supplies
- Uninterruptible Power Supplies
- Motor control

Features

- Power MOS 7[®] FREDFETs
 - Low R_{DSon}
 - Low input and Miller capacitance
 - Low gate charge
 - Fast intrinsic reverse diode
 - Avalanche energy rated
 - Very rugged
- Kelvin source for easy drive
- Very low stray inductance
 - Symmetrical design
 - Lead frames for power connections
- Internal thermistor for temperature monitoring
- High level of integration

Benefits

- Outstanding performance at high frequency operation
- Direct mounting to heatsink (isolated package)
- Low junction to case thermal resistance
- Solderable terminals both for power and signal for easy PCB mounting
- Low profile
- RoHS Compliant

Absolute maximum ratings

Symbol	Parameter	Max ratings	Unit
V_{DSS}	Drain - Source Breakdown Voltage	1000	V
I_D	Continuous Drain Current	$T_c = 25^\circ C$	22
		$T_c = 80^\circ C$	17
I_{DM}	Pulsed Drain current	88	A
V_{GS}	Gate - Source Voltage	± 30	V
R_{DSon}	Drain - Source ON Resistance	420	$m\Omega$
P_D	Maximum Power Dissipation	$T_c = 25^\circ C$	390
I_{AR}	Avalanche current (repetitive and non repetitive)	25	A
E_{AR}	Repetitive Avalanche Energy	50	mJ
E_{AS}	Single Pulse Avalanche Energy	3000	

 **CAUTION:** These Devices are sensitive to Electrostatic Discharge. Proper Handling Procedures Should Be Followed. See application note APT0502 on www.microsemi.com

All ratings @ $T_j = 25^\circ\text{C}$ unless otherwise specified

Electrical Characteristics

Symbol	Characteristic	Test Conditions	Min	Typ	Max	Unit
I_{DSS}	Zero Gate Voltage Drain Current	$V_{GS} = 0\text{V}, V_{DS} = 1000\text{V}$			100	μA
		$V_{GS} = 0\text{V}, V_{DS} = 800\text{V}$			500	
$R_{DS(on)}$	Drain – Source on Resistance	$V_{GS} = 10\text{V}, I_D = 11\text{A}$		350	420	$\text{m}\Omega$
$V_{GS(th)}$	Gate Threshold Voltage	$V_{GS} = V_{DS}, I_D = 2.5\text{mA}$	3		5	V
I_{GSS}	Gate – Source Leakage Current	$V_{GS} = \pm 30\text{V}, V_{DS} = 0\text{V}$			± 100	nA

Dynamic Characteristics

Symbol	Characteristic	Test Conditions	Min	Typ	Max	Unit
C_{iss}	Input Capacitance	$V_{GS} = 0\text{V}$ $V_{DS} = 25\text{V}$ $f = 1\text{MHz}$		5.2		nF
C_{oss}	Output Capacitance			0.88		
C_{rss}	Reverse Transfer Capacitance			0.16		
Q_g	Total gate Charge	$V_{GS} = 10\text{V}$ $V_{Bus} = 500\text{V}$ $I_D = 22\text{A}$		186		nC
Q_{gs}	Gate – Source Charge			24		
Q_{gd}	Gate – Drain Charge			122		
$T_{d(on)}$	Turn-on Delay Time	Inductive switching @ 125°C $V_{GS} = 15\text{V}$ $V_{Bus} = 670\text{V}$ $I_D = 22\text{A}$ $R_G = 5\Omega$		18		ns
T_r	Rise Time			12		
$T_{d(off)}$	Turn-off Delay Time			155		
T_f	Fall Time			40		
E_{on}	Turn-on Switching Energy	Inductive switching @ 25°C $V_{GS} = 15\text{V}, V_{Bus} = 670\text{V}$ $I_D = 22\text{A}, R_G = 5\Omega$		900		μJ
E_{off}	Turn-off Switching Energy			623		
E_{on}	Turn-on Switching Energy	Inductive switching @ 125°C $V_{GS} = 15\text{V}, V_{Bus} = 670\text{V}$ $I_D = 22\text{A}, R_G = 5\Omega$		1423		μJ
E_{off}	Turn-off Switching Energy			779		

Source - Drain diode ratings and characteristics

Symbol	Characteristic	Test Conditions	Min	Typ	Max	Unit
I_S	Continuous Source current (Body diode)		$T_c = 25^\circ\text{C}$		22	A
			$T_c = 80^\circ\text{C}$		17	
V_{SD}	Diode Forward Voltage	$V_{GS} = 0\text{V}, I_S = -22\text{A}$			1.3	V
dv/dt	Peak Diode Recovery ①				18	V/ns
t_{rr}	Reverse Recovery Time	$I_S = -22\text{A}$ $V_R = 670\text{V}$ $di/dt = 100\text{A}/\mu\text{s}$	$T_j = 25^\circ\text{C}$		320	ns
			$T_j = 125^\circ\text{C}$		650	
Q_{rr}	Reverse Recovery Charge		$T_j = 25^\circ\text{C}$	3.6		μC
			$T_j = 125^\circ\text{C}$	9.72		

① dv/dt numbers reflect the limitations of the circuit rather than the device itself.

$$I_S \leq -22\text{A} \quad di/dt \leq 700\text{A}/\mu\text{s} \quad V_R \leq V_{DSS} \quad T_j \leq 150^\circ\text{C}$$

Thermal and package characteristics
Symbol Characteristic

		<i>Min</i>	<i>Typ</i>	<i>Max</i>	<i>Unit</i>	
R _{thJC}	Junction to Case Thermal Resistance			0.32	°C/W	
V _{ISOL}	RMS Isolation Voltage, any terminal to case t = 1 min, I _{isol} < 1mA, 50/60Hz	2500			V	
T _J	Operating junction temperature range	-40		150	°C	
T _{STG}	Storage Temperature Range	-40		125		
T _C	Operating Case Temperature	-40		100		
Torque	Mounting torque	To Heatsink	M5	2.5	4.7	N.m
Wt	Package Weight				160	g

Temperature sensor NTC (see application note APT0406 on www.microsemi.com for more information).

Symbol Characteristic

		<i>Min</i>	<i>Typ</i>	<i>Max</i>	<i>Unit</i>
R ₂₅	Resistance @ 25°C		50		kΩ
B _{25/85}	T ₂₅ = 298.15 K		3952		K

$$R_T = \frac{R_{25}}{\exp\left[B_{25/85}\left(\frac{1}{T_{25}} - \frac{1}{T}\right)\right]}$$

T: Thermistor temperature
 R_T: Thermistor value at T

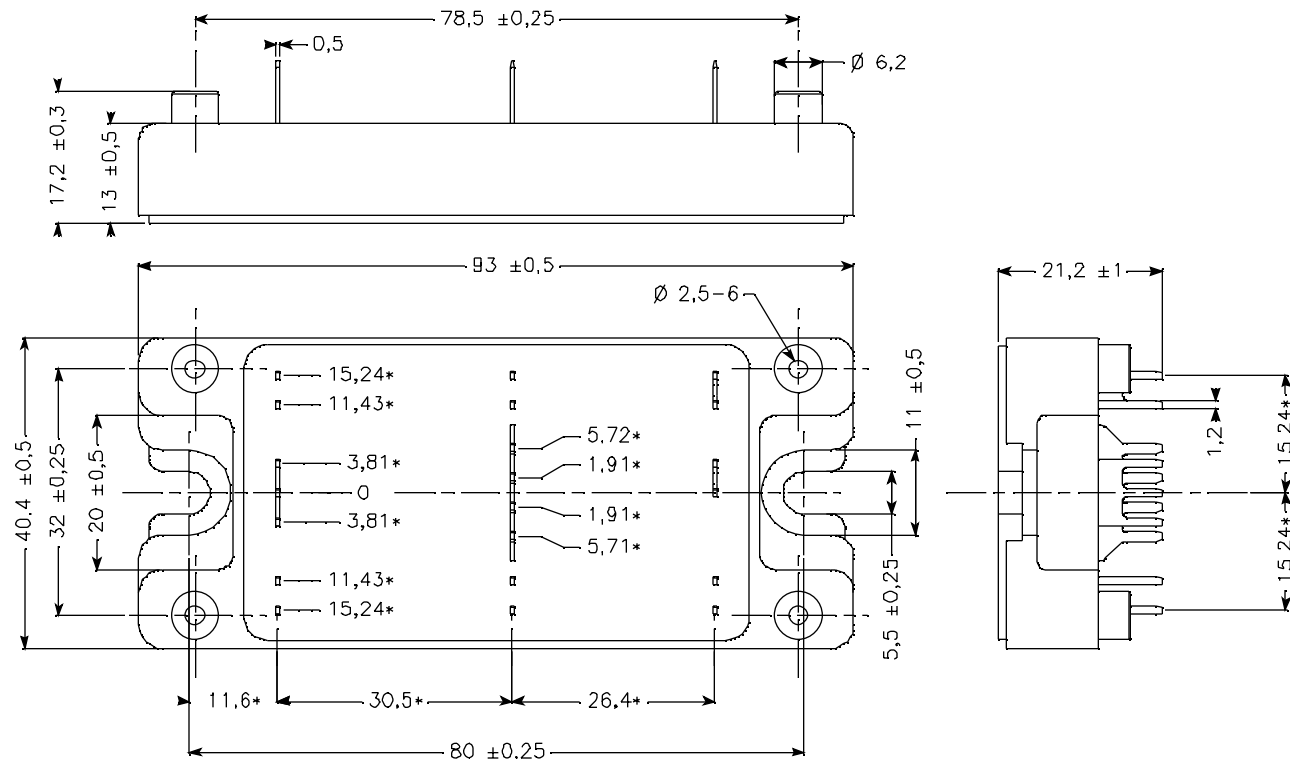
SP4 Package outline (dimensions in mm)

 ALL DIMENSIONS MARKED "*" ARE TOLERENCED AS: $\oplus \ominus 0.1$

See application note APT0501 - Mounting Instructions for SP4 Power Modules on www.microsemi.com

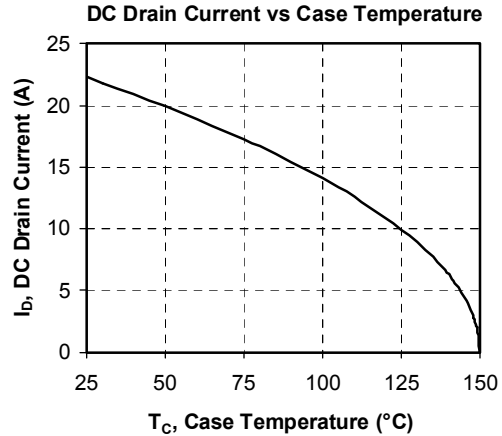
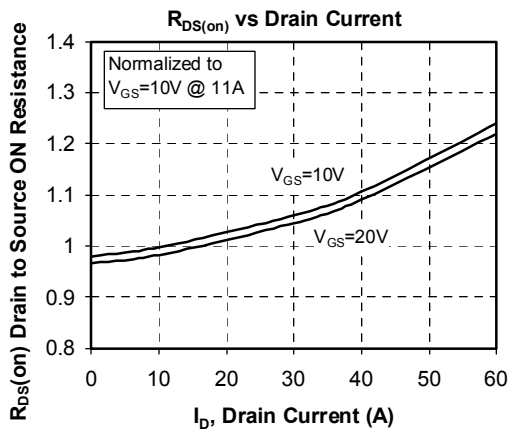
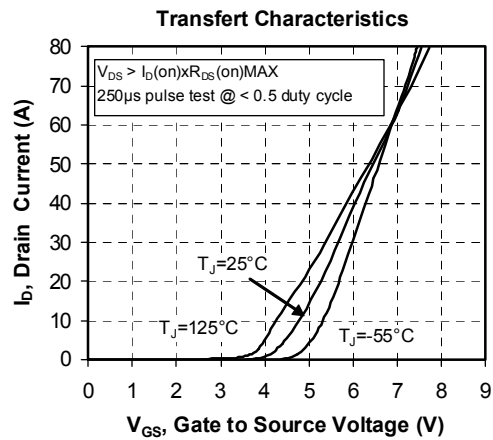
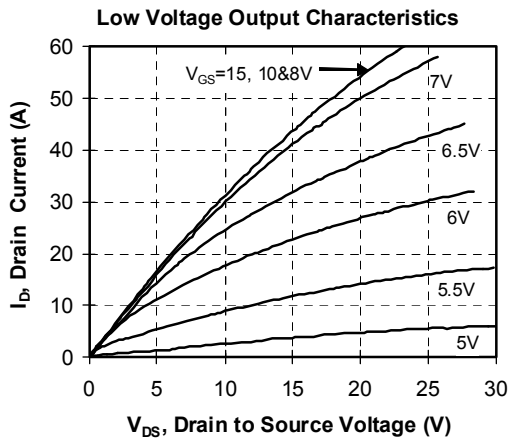
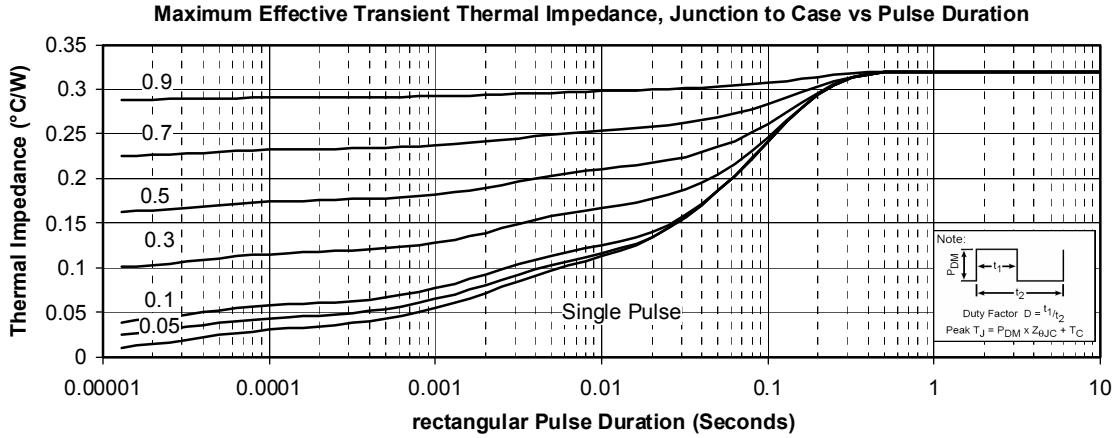
Typical Performance Curve

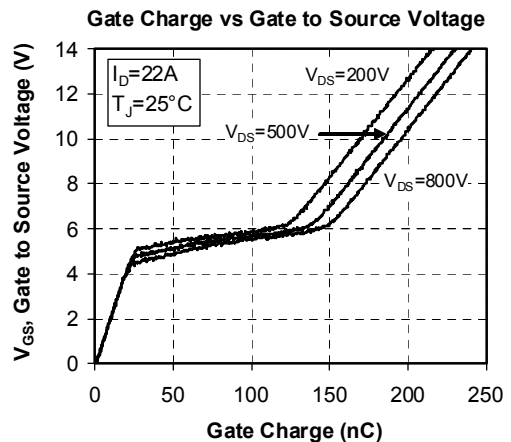
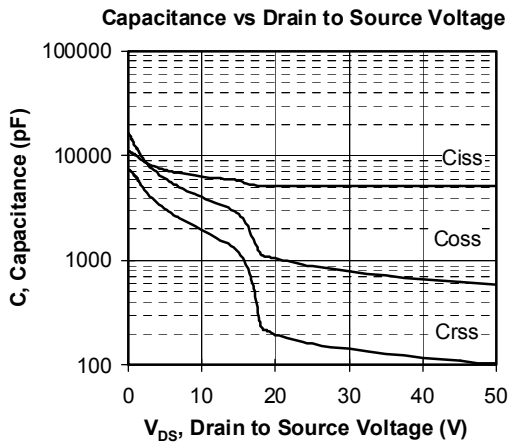
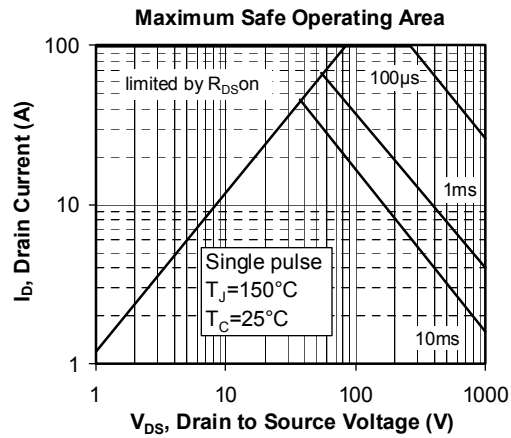
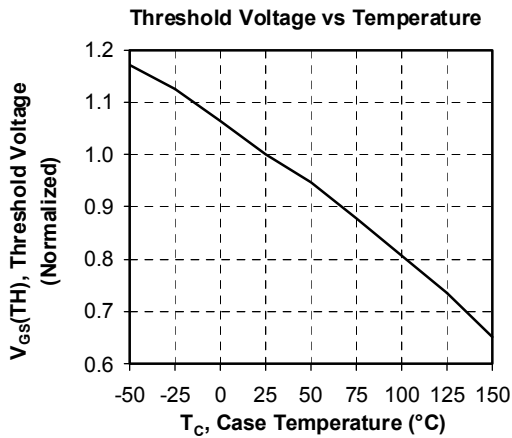
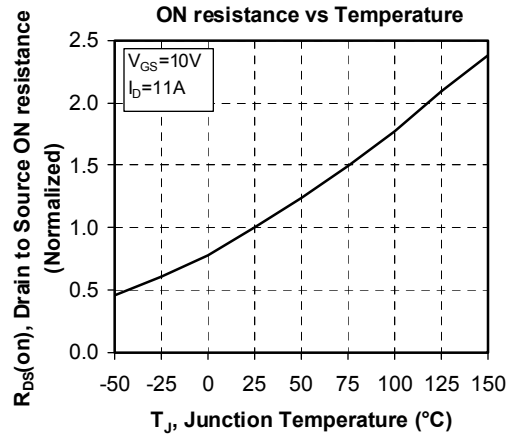
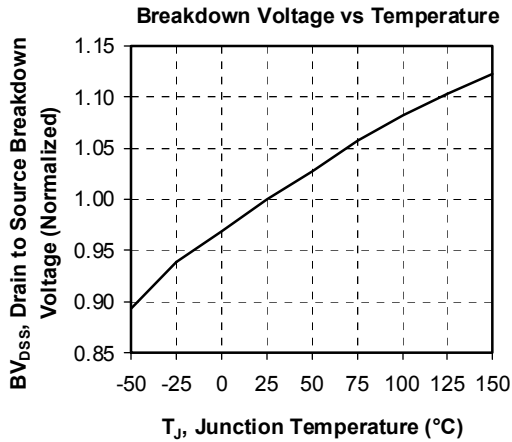

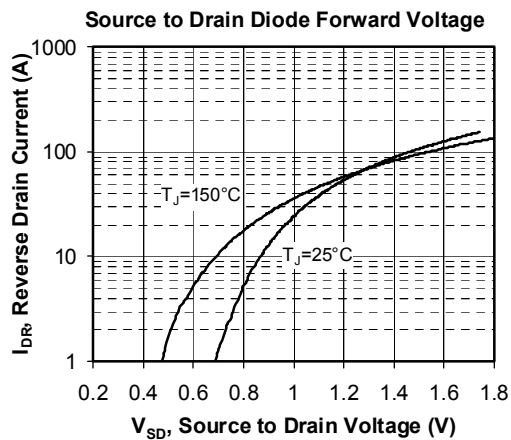
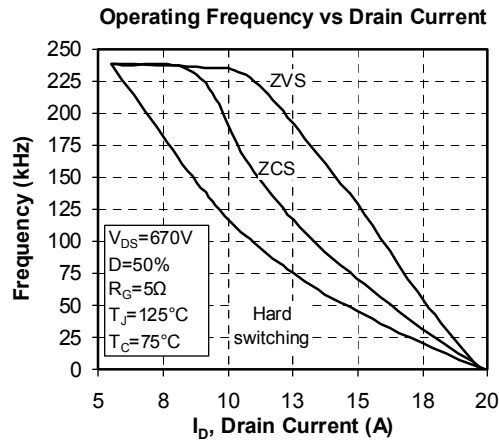
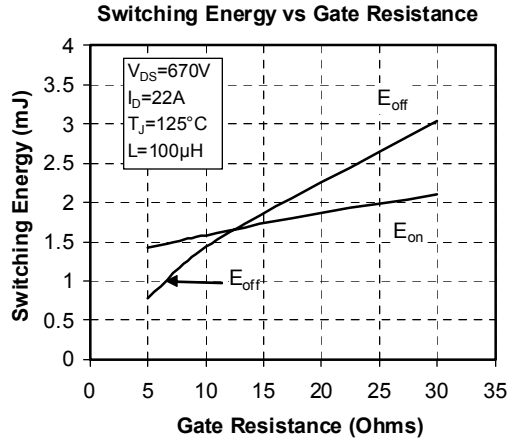
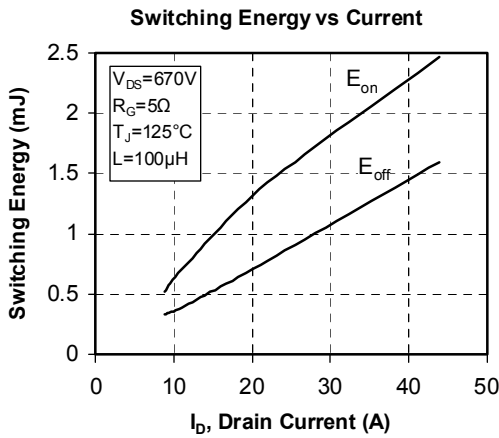
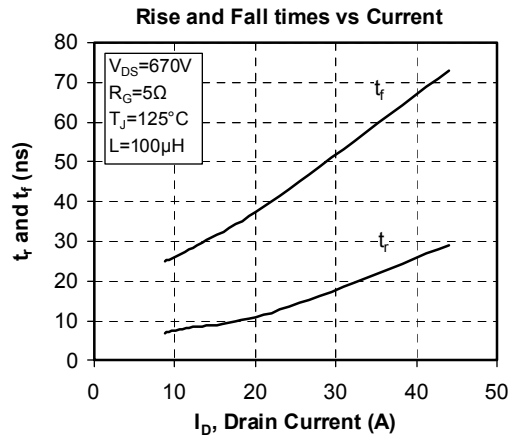
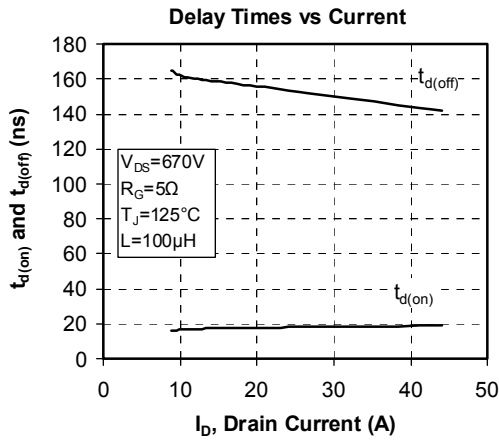



Microsemi reserves the right to change, without notice, the specifications and information contained herein

Microsemi's products are covered by one or more of U.S. patents 4,895,810 5,045,903 5,089,434 5,182,234 5,019,522 5,262,336 6,503,786 5,256,583 4,748,103 5,283,202 5,231,474 5,434,095 5,528,058 and foreign patents. U.S. and Foreign patents pending. All Rights Reserved.